



TS-96

Automated Nucleic Acid Extractor

Operation Manual



TransGen Biotech Co., Ltd.

Catalogue

I Introduction	1
1.1 About the Manual.....	2
1.2 About Warning Symbols	2
1.2.1 The Meaning and Extend of Warning Words	2
1.2.2 Explanation of Warning Symbols.....	2
1.2.3 Explanation of Instrument Safety Symbols	3
1.3 Safety Instructions.....	3
1.3.1 Instrument Classification.....	3
1.3.2 Safety Instruction	4
1.4 Instrument Transportation and Storage Conditions.....	6
1.5 Environmental Requirements for Instrument Operation	6
1.6 Power Conditions	6
1.7 Basic Parameters	6
1.8 Power Supply Connection	6
II Controls and Functions	8
2.1 Function Introduction.....	8
2.2 Main Structure	8
2.2.1 Front View	8
2.2.2 Input and Output Connections	8
2.2.3 External Buttons.....	9
2.3 Function	9
2.4 Main Performance Indicators.....	9
2.5 Product Features and Scope of Application	9
2.5.1 Product Features	9
2.5.2 Intended Use	10
2.5.3 Scope of Application:	10
2.5.4 Contraindications	10
2.6 Product Principle	10
III Preparation before Use	11
3.1 Selection of Working Site	11
3.2 Installation and Removal of Supporting Consumables	11
3.3 Power Connection and Startup	13
IV Operating Instructions	14

4.1 Switch On	14
4.2 Program Management Function	15
4.2.1 Add	16
4.2.2 Edit	26
4.2.3 Delete	27
4.2.4 Copy	27
4.2.5 Import	27
4.2.6 Export	28
4.2.7 Return	28
4.3 Program Extraction	28
4.4 Retrieving Records	32
4.5 UV Lamp	32
4.6 User Management	34
4.7 Change Password	36
4.8 Maintenance Test	37
4.9 System Settings	39
V Repair and Maintenance	40
5.1 Maintenance Guidelines	40
5.2 Periodic Check	40
5.3 Common Failures Analysis	42
5.4 Main components Replacement Method	43
5.4.1 Fuse Replacement Method	43
5.4.2 Connection Cable Replacement Method	43
VI Electromagnetic Compatibility	44
VII After-sales Service	45
7.1 Warranty Description	45
7.2 Maintenance Service	45
7.3 After-sales Service Unit Information	45

I Instruction

Welcome to use the TS-96 Automated Nucleic Acid Extractor. This manual gives a detailed description of the purpose, function and use of the TS-96 Automated Nucleic Acid Extractor. Please read this manual carefully before use, to make sure you use it correctly and understand its functions when you turn on the instrument, and ensure the safety of the operator. Please place this manual nearby the instrument for a timely reading if necessary.

Product name: TS-96 Automated Nucleic Acid Extractor

Product model: TS96

Date of manufacturer: See the label

Product Shelf life: 5 years

Date of issue and edition: August 2020, version: A

1.1 About the Manual

This manual provides information on the proper use of the TS-96 Automated Nucleic Acid Extractor. It is divided into seven chapters.

Chapter 1 "Introduction": It chapter introduces the safety requirements while using the product, and the restriction conditions of transportation and storage environment, etc.;

Chapter 2 "Control and Function": It mainly illustrates the product function, structure, key performance indicators, product characteristics, range of application and product principles;

Chapter 3 "Preparation before Use": It mainly introduces the site selection, consumable item installation, and the usage of keys on instrument before use;

Chapter 4 "Operation Instructions": It mainly introduces the functional modules of the Nucleic Acid Extractor;

Chapter 5 "Repair and Maintenance": It mainly introduces the professional preventive check of the instrument, the methods and cycles of maintenance and cleaning, and the analysis of common malfunctions;

Chapter 6 "Electromagnetic Compatibility": It mainly introduces the electromagnetic compatibility requirements and also clarifies the cautions needed to pay attention for normal operation of the instrument;

Chapter 7 "After-sales Service": It mainly explains the product warranty and maintenance services, and also provides the contact information of after-sales service units.

1.2 About Warning Symbols

1.2.1. The Meaning and Extend of Warnings

 Note: Failure of following the requirements may cause personal injury or instrument damage;

 Warning: Failure of following the requirements may cause personal casualties, accidents or fire hazards.

1.2.2. Description of Warning Symbols





 Caution; Indicates the user need to pay attention on the important cautionary information;

 Prohibited operation, failure of complying with the requirements may cause instrument damage, failure to work or injury to the operator;





 Peremptory instructions.

1.2.3. Description of Safety Symbols

(1) Instrument Safety Mark Description

 Protective Earth Terminal	 Dangerous Voltage
~ AC Power	 Biological Hazard
On (Power)	○ Off (Power)
 Beware of burns	 IVD (In vitro diagnostic medical devices)

(2) Outer Packaging Label Description

 To be protected from rain;
 The stacking layer limit is 2 layer;
 Top: Indicates that the correct position of the transport package is upright;
 Fragile, handle with care;
 Do not roll: Indicates that the transport package cannot be rolled during transportation.

1.3 Safety Instructions

● To enable you successfully complete your work and give full play to the functions of this instrument. Please read this manual carefully before use. Please feel free to contact us in case of any inquiries or comments on our product or this manual.

● To ensure the safe and reliable operation of the instrument, the user shall comply with the following requirements in daily operation:

- 1) To ensure the safety of the product, maintenance, repair and replacement of parts shall be carried out by our company's professional engineers or qualified maintenance personnel trained by our company;
- 2) The instrument shall only be replaced with parts recommend by our company. It is essential to ensure the safety and effectiveness of the instrument;
- 3) To ensure that the instrument shall adopt the correct voltage and frequency as required;
- 4) In case of a lightning in the surrounding, it may cause voltage shock in TS-96 which may cause danger. It is recommended to unplug the power cord from the AC outlet and stop using.

1.3.1 Instrument Classification

Overvoltage Category: Class II











Pollution Degree: Level 2

Management Category: Class I

1.3.2 Safety Usage Instructions

1. Before using the TS-96 Automated Nucleic Acid Extractor, make sure to read this section to ensure safe and correct operation. The following measures are related to safety and must be strictly followed.

2.  Warning: General requirements







-  Please read this manual carefully before using the instrument;
-  Do not spill or pour liquid into the instrument, do not put the instrument in liquid, or place the instrument where it may fall into the liquid; if the device becomes visibly wet, unplug the power cord immediately;
-  When the instrument is connected to the power supply, do not leave the equipment unattended;
-  Use this equipment only for the purposes described in the manual, do not use it for other purposes;
-  Please do not use accessories not provided or recommended by the manufacturer;
-  If the equipment is not working properly or is damaged, please do not use the device;
-  Do not allow the device or the flexible cord of the device touch overheated surfaces;
-  Do not block the vents, or place the device on a soft surface that may block the vents, and keep the vents away from soft cloth, fluff, soft hair, etc.
-  Do not place any objects on the top of the device;
-  Do not use outdoors;
-  Protective Measures: Do not open the hatch door during operation.







3.  Warning: Connecting part

 If the power cords of several different instruments are connected together through a multi-purpose socket, the increase of the leakage current of the enclosure may cause potential danger;

 Before connecting to the power supply, ensure that the setting of the connected voltage matches the power supply voltage required by the device.

4.  Warning: Power requirements

-  Be sure to connect the AC power cord to the medical three-core power socket. If there is no such socket, please use a ground wire to connect the instrument securely.
- 5.  Warning: Anti-explosion requirements
 -  Do not operate TS-96 in a working environment with potential explosion hazards, and do not operate TS-96 in the presence of flammable anesthetic gas;
 -  Do not use a high pressure sterilizer, strong oxidants for sterilization, or immerse the nucleic acid extractor in disinfectant.
- 6.  Warning: Preventive check and maintenance
 -  In order to make the instrument run under safe conditions and prevent from potential problems during use, preventive check and maintenance is essential. Generally, preventive maintenance is carried out at least once a year, including a thorough check of the instrument and all connecting cables. Before using the instrument, if the following physical damage occurred, it must be maintained immediately.
 - If the instrument is subjected to excessive impact, such as after a heavy fall;
 - If solids or liquids fall on or flow into the instrument;
 - If the instrument cannot work normally or an abnormality occurs during operation;
 - If some parts of the outer case are cracked or damaged;
 - If the power cord shows signs of damage.
- 7.  Note: Transportation and storage

TS-96 shall be packed in specific packaging materials, and transported and stored under specific conditions.
- 8.  Note: General precautions
 -  Do not store the instrument in a place with potential liquid corrosion;
 -  Do not place the device in a location where the power switch is difficult to reach or operate, such as: the power switch faces the wall;
 -  Do not expose the instrument under strong impact or vibration, and do not fall it down;
 -  If the equipment needs to be lifted or transported, please apply a uniform external force greater than its weight at the bottom of the device and move it steadily to avoid overturning or falling;
 -  Avoid of strong impact for display screen; improper impact may damage its components;

! When unplugging the power cord, please pull out the plug, do not directly pull the power cord itself. Besides, do not plug and unplug the power cord with wet hands, which may cause electric shock, short circuit or personal injury;

! Please use a soft cloth or cloth dipped in clean water or neutral solution to wipe the dust and dirt adhere to the surface of the screen.

1.4 Transportation and Storage Conditions

1. Ambient temperature range: $-20^{\circ}\text{C} \sim +55^{\circ}\text{C}$;
2. Relative humidity range: $\leq 80\% \text{ RH}$;
3. Atmospheric pressure range: $75\text{kPa} \sim 106\text{kPa}$.

1.5 Operating Environment Conditions

1. Ambient temperature range: $+5^{\circ}\text{C} \sim +40^{\circ}\text{C}$;
2. Relative humidity range: $\leq 80\% \text{ RH}$;
3. Atmospheric pressure range: $75\text{kPa} \sim 106\text{kPa}$.

1.6 Power Conditions

1. Rated voltage: $\text{AC}220 \sim 240\text{V}$;
2. Voltage frequency: $50/60\text{Hz}$;
3. Input power: 400VA .

1.7 Basic Parameters

1. Maximum sample extraction: 96;
2. Temperature control range: room temperature $\sim 120^{\circ}\text{C}$;
3. Processing volume: $50\text{-}1000 \mu\text{L}$;
4. Product size: $730 \times 547 \times 605 \text{ (mm)}$;
5. Net weight: 62Kg .

1.8 Connect to the power supply

1. Please connect to AC power.
2. Use an AC power socket with a ground wire, and ensure the ground wire is effectively connected with the device.
3. In case of a lightning in the surrounding, which may bring voltage shock in TS-96 and cause potential danger, it is recommended to unplug the power cord from the AC outlet and cease using the device.

4. After the nucleic acid extraction is completed, you can click the Power Off button at the bottom right of the display screen to shut down the device. After the system is shut down, turn off the power at the back of the device.

II Controls and Functions

2.1 Function introduction

The TS-96 Automated Nucleic Acid Extractor is an in vitro diagnostic device, which is used to extract and purify nucleic acids from biological samples. Through the mixing of liquids, the collection, release and transfer of magnetic beads, the extraction and purification of nucleic acids are automatically realized. The equipment has a temperature control function and can extract 1-96 samples at the same time, which truly realizes the high-throughput, rapid and automated extraction of nucleic acids. The equipment is equipped with different types of nucleic acid extraction kits, which can extract and purify nucleic acids from biological samples such as blood, plasma, saliva, oral swabs, viruses, animal and plant tissues, bacteria, microorganisms.

2.2 Main Structure

2.2.1 Front View



Figure 2-1 TS-96 Main Structure

2.2.2 Input and Output Connections



Table 2-1

Serial No.	Interface Name	Description of Functions
1	LAN Port	Reserved

2	USB2.0 Port	Used to connect U disk, keyboard or mouse
3	Power Input Port	Single-phase AC input power, with grounding protection

2.2.3 External Buttons

Table 2-2

Serial No.	Button Name	Description of Functions
1	Power Switch	After the network power is turned on, the power switch controls the start of the device
2	Turntable Button  (clockwise)	When pressed, the turntable rotates clockwise for one work station.
3	Turntable Button  (counterclockwise)	When pressed, the turntable rotates one work station counterclockwise.

2.3 Function

1. Open door pause function;
2. Emergency stop function;
3. Prompt function by the end of nucleic acid extraction;
4. Program import and export functions;
5. Ultraviolet lamp disinfection function.

2.4 Main Performance Indicators

1. Working temperature: setting range: room temperature to 120°C;
 temperature accuracy: $\pm 5^{\circ}\text{C}$ ($\leq 90^{\circ}\text{C}$), $\pm 8^{\circ}\text{C}$ ($> 90^{\circ}\text{C}$);
2. The recovery rate of magnetic beads: >98%;

2.5 Product Features and Scope of Application

2.5.1 Product Features

1. With temperature control function, it realizes the temperature conversion from room temperature to 120°C, which can meet different temperature requirements of the nucleic acid extraction process.
2. Fast extraction speed: A whole nucleic acid extraction process can be completed in about 30 minutes.
3. Ultraviolet disinfection function avoid cross contamination.

4. User management function, with different user permissions to meet different occasions.
5. USB interface can fast input and output running programs.
6. A 10-inch LCD screen can synchronize the nucleic acid extraction process.
7. With its touch function, users can easily create and edit running programs on the device.

2.5.2 Intended Purpose

This instrument is used for the extraction and purification of nucleic acids in clinical samples.

2.5.3 Scope of Application: All people.

2.5.4 Contraindications

Not found.

2.6 Product Principle

The nucleic acid extractor realizes the separation and extraction of nucleic acid through the transfer of magnetic beads. The device uses the movement of the magnetic rod to realize the transfer of magnetic beads from the sample lysis solution, washing solution, and then to the eluent, and automatically completes the whole process of nucleic acid extraction and purification through temperature control.

The process and principle include the following steps:

- 1) Lysis: Add the sample to be processed into the lysis solution containing magnetic beads, fully mix, and lyse the cells under appropriate heating conditions;
- 2) Mixing: the released nucleic acid is specifically adsorbed to the magnetic beads, and the lysed protein and other molecules which are not adsorbed remain in the reagent solution;
- 3) Washing: Under the action of the magnetic field of the magnetic rods, the magnetic beads are separated from the solution, and the magnetic beads are transferred to the washing solution through the movement of the magnetic rods. Through repeated washing, impurities such as protein and inorganic salts are removed;
- 4) Elution: After the washing step, the magnetic beads are transferred to the eluate by the movement of the magnetic rods, and the nucleic acid is eluted from the magnetic beads. At last, the magnetic beads are removed by the movement of the magnetic rods and thus complete the whole process of extraction and purification of the nucleic acid.

III Preparation before Use

The TS-96 Automated Nucleic Acid Extractor is composed of mechanical parts and electrical parts, and is used with the kit to realize the separation and extraction of nucleic acids in test samples.

Before using the device, make sure that you fully understand the information of the kit and read this manual carefully.

3.1 Selection of Working Site

1. Please install the nucleic acid extractor in strict accordance with the following method.

(1) Use a three-wire AC power socket with a ground wire, and ensure the ground wire is effectively connected with the device;

(2) If there is strong electromagnetic radiation around, it will cause different degrees of interference to the machine, such as leakage current, electrostatic induction, electromagnetic induction, coupling magnetic flux, etc. Please make sure that there are no high-voltage lines and heavy-load power lines passing nearby the device.

2. Please use it under the specified temperature, humidity and atmospheric pressure.

3. The equipment should be placed in a wide place for easy operation and use, with good ventilation condition. Don't place the equipment where it is difficult to operate the power switch.

4. The weight of the device is 62kg. In order to prevent the platform for placing the machine from collapse, the load-bearing capacity of the platform is required to be at least 80kg.

3.2 Installation and Removal of Supporting Consumables

This instrument is used together with magnetic bead method nucleic acid extraction kit and consumables.

Well plate installation, as shown in Figure 3-1 below.

Please pay attention to the direction: A1 is inward.

Open the hatch door of the device, and place the magnetic sleeves and the kit on the corresponding work station, as shown in Figure 3-1.

The magnet sleeves can be installed at any work station, as shown in Figure 3-2, install the magnet rods sleeve evenly in place.

Consumable installation and installation location should be consistent with the equipment operating procedures.

Each work station has limiting device, please install each work station correctly.

After nucleic acid extraction is completed, please remove the consumables and close the hatch door.

During the installation and removal of consumables, turntable button can be used to rotate the turntable to the designated position.



Figure 3-1 Consumables Installation



Figure 3-2 Work Station 1 Installation

 Note: Please install the consumables correctly;

Please check the expiration date of the kit and consumables before using. Do not use if it exceeded the expiration date.

Please perform personal safety and hygiene protection as required on the experimental site;

Waste disposal after use shall be subject to the *National Medical Waste Management Regulations*, relevant regional laws and regulations or relevant laboratory management regulations;

Please read carefully the application methods and precautions in the instructions of the kits and consumables, and use them as specified in the regulations.

 Note: Do not use the device in hazardous environments or use hazardous materials beyond the designed range.

3.3 Power Connection and Startup

Connect the power cord to the power socket at the back of the device, and the other end to an adaptable AC power outlet. Turn on the power switch at the back of the device to startup.

IV Operating Instructions

4.1 Switch On

Turn on the switch of the Automated nucleic acid extractor, the device will startup and initialize, reset and self-check all moving parts, and enter the login interface after the self-check is completed, as shown in Figure 4-1.



Figure 4-1 Login interface

On the login interface, the user can enter the user name and password, and click the "Login" button to enter the main interface. On the login interface, the default user name for the first login is **admin**, the default password is **000 000**, and each login defaults to the last login user name.

The device will pop up a keyboard where you need to input information. After the input is completed, click elsewhere on the interface to confirm the operation, the keyboard will automatically exit.

Enter the main interface from the login interface, as shown in Figure 4-2.

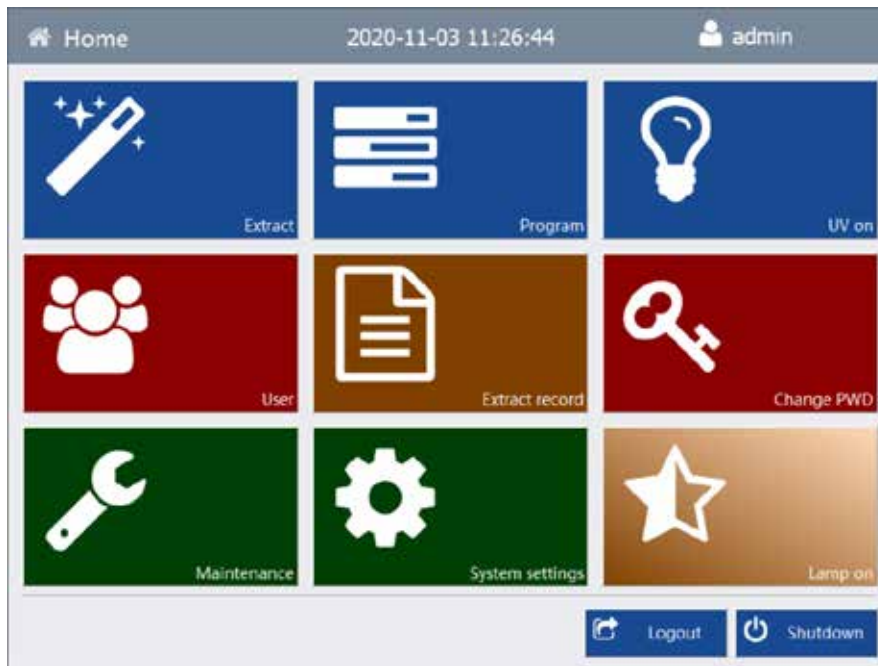

Figure 4-2 Main interface

The main interface includes the major functions of the device:

1. **Nucleic Acid Extraction:** preset extraction program, the main function of this module is to select the programmed operating program, execute the corresponding program, operate and complete the nucleic acid extraction of biological samples;
2. **Program Management:** program management mainly used to add and edit the extraction process program and parameter settings to be executed;
3. **Ultraviolet Lamp:** Ultraviolet lamp sterilizes the instrument test chamber;
4. **User Management:** User management sets users and user permissions;
5. **Extraction Record:** Extraction record views the past programs that the device had run;
6. **Change Password:** Change the password and modify the current user's password;
7. **Maintenance:** Maintenance is set to examine if the function of each moving parts is normally operated;
8. **System Settings:** System settings set the operating parameters of the device;
9. **Lighting Lamp:** lighting lamp to illuminate the test chamber;
10. Logout, shutdown, time and account display.

4.2 Program Management Function

Click the "Program Management" button on the main interface, the program list interface shows, as shown in Figure 4-3, and at the same time it also displays "Create", "Edit", "Delete", "Copy",

"Import", "Export", "Back" function buttons. The program list interface displays the information of the program that has been programmed, including program name, the creator, creation date, and editing time. Each compiled program will be displayed in the program list. The editing time is the last time the program was edited and used.

The user can select the corresponding keyword in the search box, click the search button to search for the program related to the keyword; click the page up and down keys to manually find the desired program.

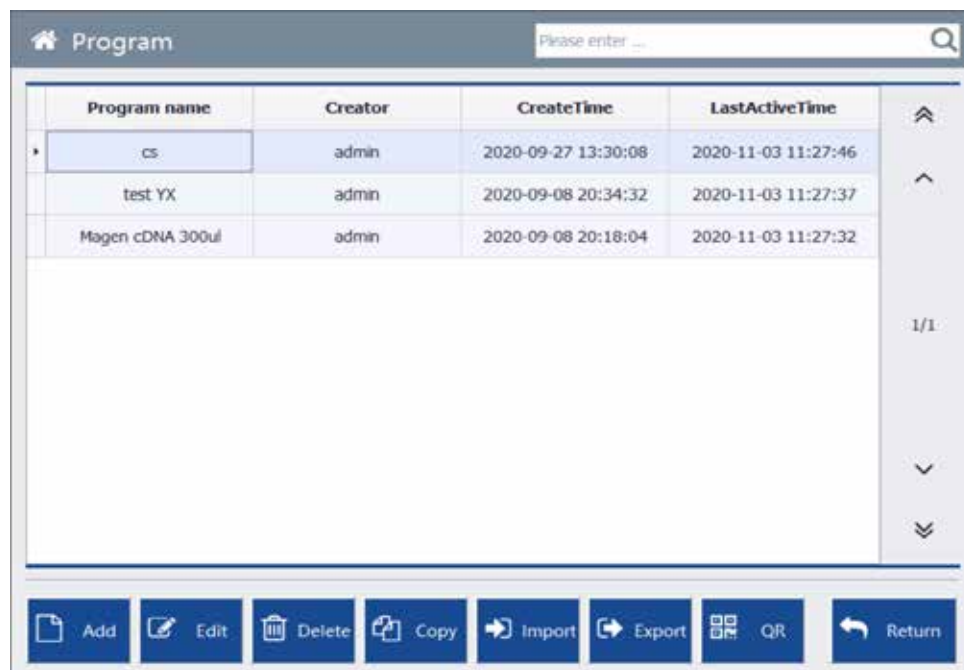

Figure 4-3 Program Management

4.2.1 Add

Click the "Add" button to enter the program interface for programming.

The programming is mainly composed of 7 functional modules: "Abstract", "Reagent", "Mix", "Collect", "Release", "Pause" and "Dry".

Summary: When programming, enter the "Abstract" interface by default, as shown in Figure 4-4.

Name: to fill in the name of the compiled program, default name: Program + year, month, day and time;

Check Reagent Kit: The user selects whether to check the reagent kit when running the program. The device defaults to check whether the reagent kit is installed when running the program. If it is

not selected, it means that the reagent kit is not checked when running the program. Users chooses whether to check the reagent kit as needed;

Remarks: Add other information about the program;

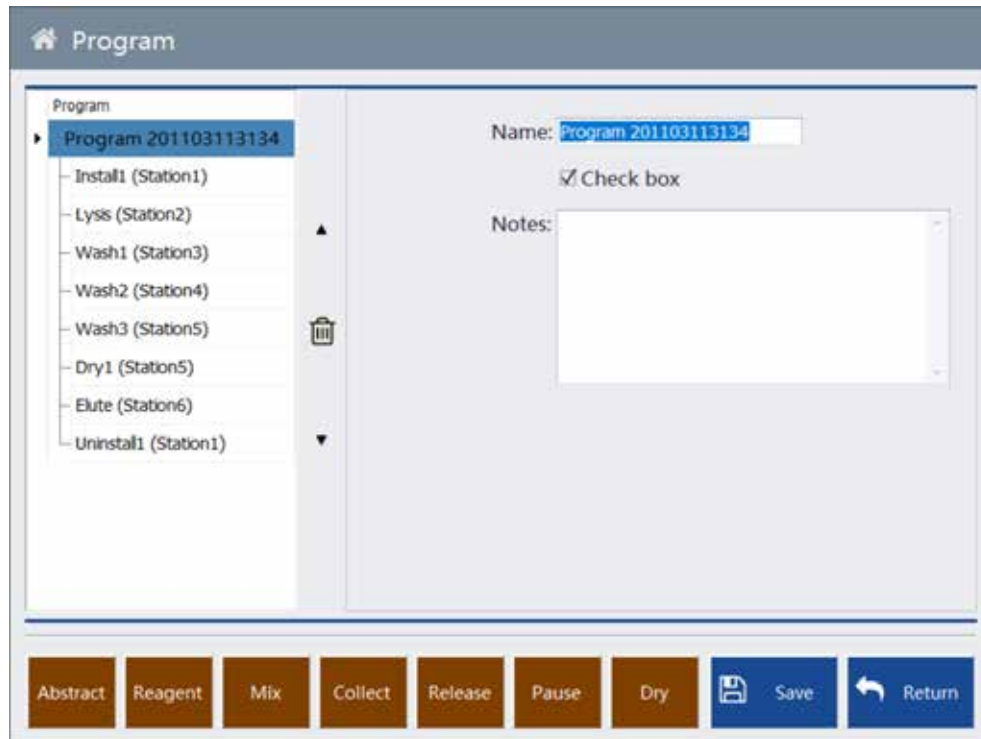

Figure 4-4 Abstract

Reagents: Fill in the volume of the sample and reagents to be added in the well of each work station.

Click the "Reagent" button to enter the reagent interface to fill in the volume of the reagent added in the reagent cartridge of each work station, as shown in Figure 4-5.

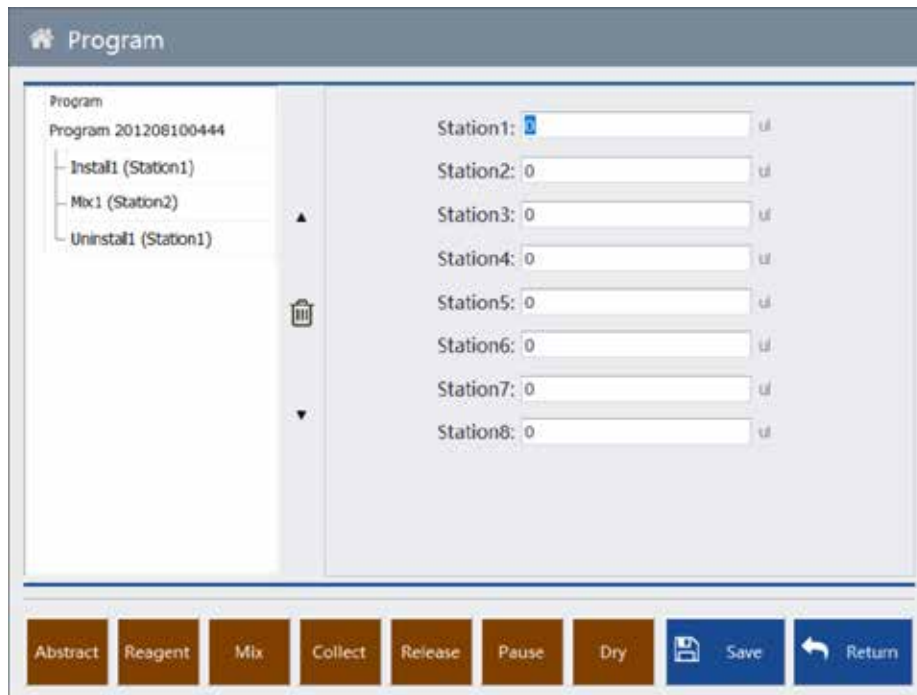

Figure 4-5 Reagent

Click the reagent volume edit box to enter the reagent setting interface to set the reagents and their volumes required for each well of the cartridge, as shown in Figure 4-6.

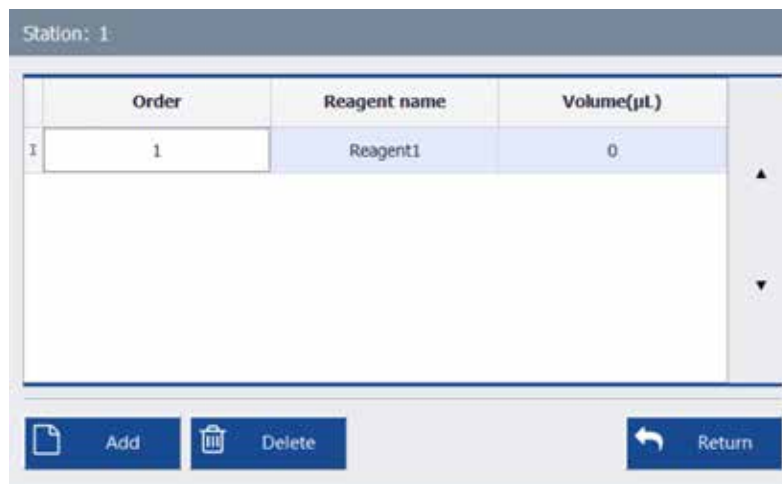

Figure 4-6 Reagent Settings

Click the "Add" button in the reagent settings to add reagents, you can set the reagent name, reagent volume, and up to five reagent information to be filled in, and move the position order by pressing the up and down buttons.

Note: The maximum volume of liquid in each well is 1000uL. The device will prompt if adding volume of reagents and samples exceed the maximum.

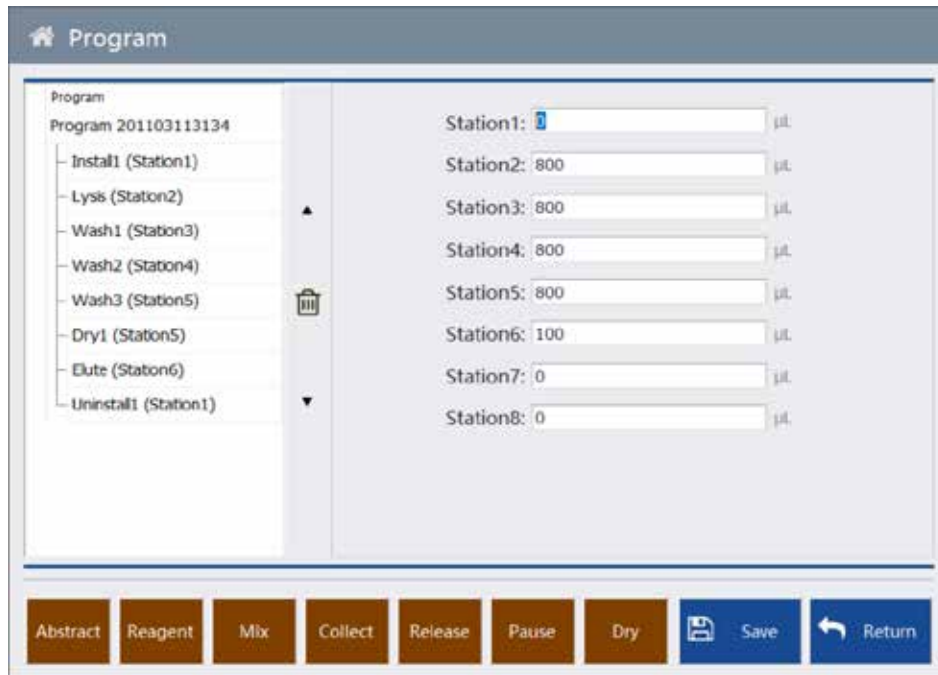

Figure 4-7 Reagent Information

For unnecessary reagent column information, select and click the "🗑️" button to delete.

After the setting is completed, click the "Return" button to save and close the reagent setting.

Follow the above steps to set the reagent information in other columns, as shown in Figure 4-7.

Note: The reagent information shown above is for illustration only, and operator needs to insert the corresponding reagent information based on actual condition;

Mixing: This function is mainly to complete the release of magnetic beads, mixing and collecting magnetic beads of the sample reagents in the kit, including:

Initial Mixing: shows the position, time and speed of the release of magnetic beads, as shown in Figure 4-8-1

Heating Mixture: shows the speed, time and heating of (mix heating), as shown in Figure 4-8-2

End Mixing: shows the frequency and time of collecting magnetic beads, as shown in Figure 4-8-3

Click "<", ">" to switch among initial mixing, heating mixture, and end mixing interfaces.

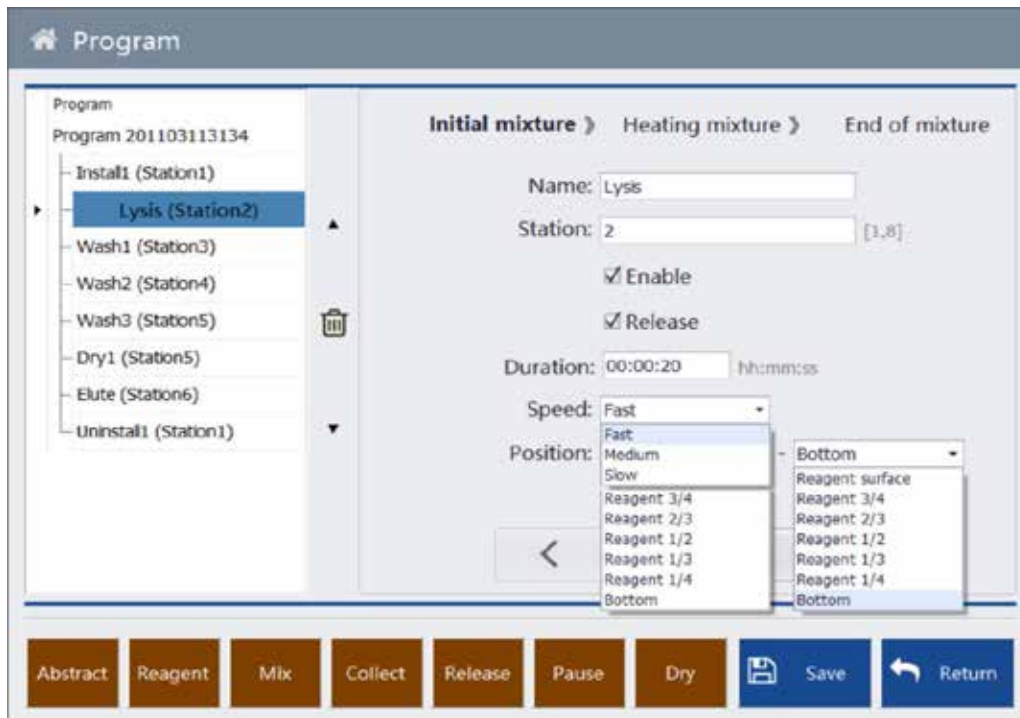

Figure 4-8-1 Initial Mixing

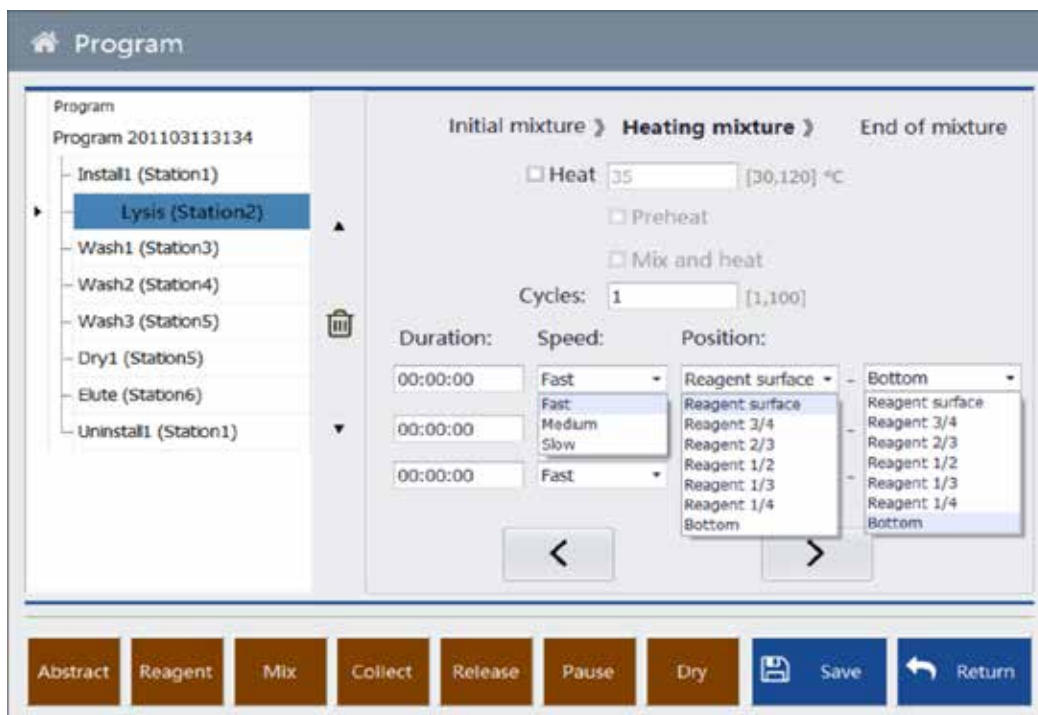

Figure 4-8-2 Heating Mixture

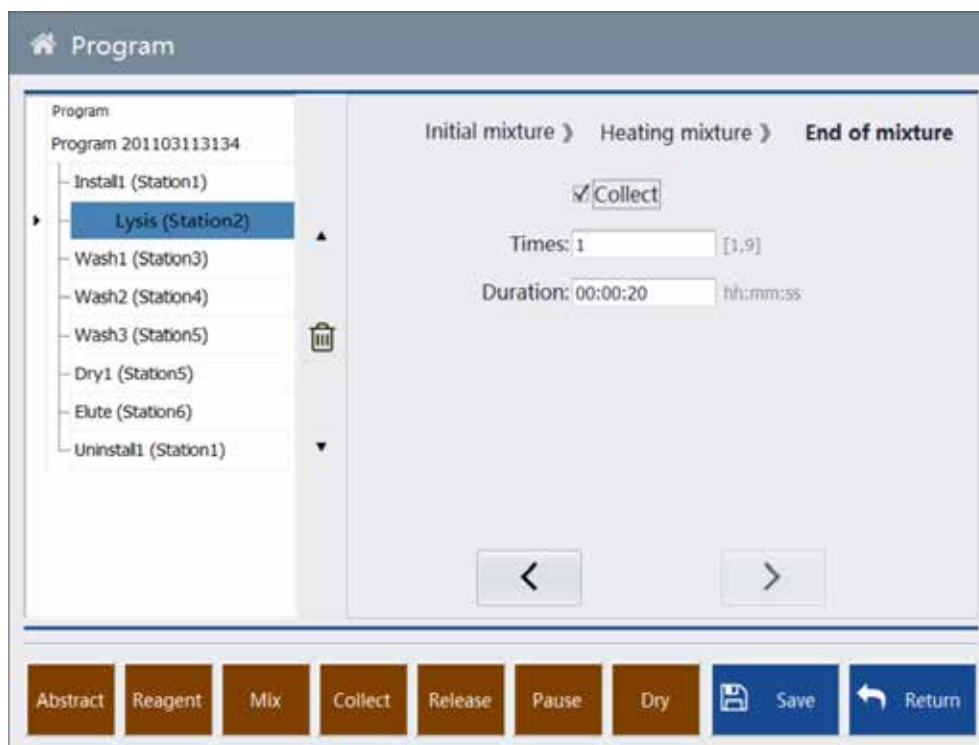

Figure 4-8-3 End Mixing

Initial mixing:

Name: The default name is Mix 1, and 1 represents the first mixing step. If you click "Mix" again, it will display "Mix 2", "Mix 3"..., the operator can modify accordingly;

Work station: select the work station where the mixing step is located;

Enable: select whether this mixing step is enabled, the default is enabled, if not selected, this step will be skipped during the execution of the program, and execute the next step directly;

Release magnetic beads: Select whether to release the magnetic beads in this initial mixing step. The default selection is enabled. If it is not selected, this step will be skipped during the program execution and the next step will be directly executed;

Time: Set the time for magnetic beads release;

Speed: Set the vibration speed of the magnetic rod sleeve. There are three types of speed to set: fast, medium and low;

Position: Set the operating position of the magnetic beads released inside the reagent. The first parameter is the starting position of the vertical direction, and the second parameter is the end position of the vertical direction. There are seven positions that can be set: the surface, 3/4, 2/3, 1/2, 1/3, 1/4 and the bottom;

Mix heating

Time: Set the time for vibration operation;

Speed: Set the vibration speed of the magnetic rod sleeve. There are three speeds to set: fast, medium and low;

Position: Set the operating position of the magnetic beads released inside the reagent. The first parameter is the starting position of the vertical direction, and the second parameter is the end position of the vertical direction. There are seven positions that can be set: the surface, 3/4, 2/3, 1/2, 1/3, 1/4 and the bottom;

Heating: Select whether to heat or not: no heating by default. If heating is needed, click “check” in the box and set the heating temperature. If the set temperature is lower than the current temperature, it will not be heated. Heating temperature range: 30~120°C;

Preheating: Select whether to preheat or not: no pre-heating by default. If pre-heating is required, click “check” in the box. When the program is running, the heating block is preheated to the use temperature;

Heating and Mixing: If select, mixing will start while heating is started; if not selected, the mixing will start when the temperature reaches the set temperature;

End mixing:

Collect magnetic beads: select whether magnetic beads are collected by the end of the mixing step. The default option is enabled. If it is not selected, this step will be skipped and the execute the next step directly;

Work station: select the work station of the collection step;

Times: number of times for collections;

If multiple mixing steps are required in the program, please set up multiple mixing steps and set the corresponding work stations.

Collect: This function is mainly to collect the magnetic beads in kit, including the location, times, and set duration of stay. As shown in Figure 4-9.

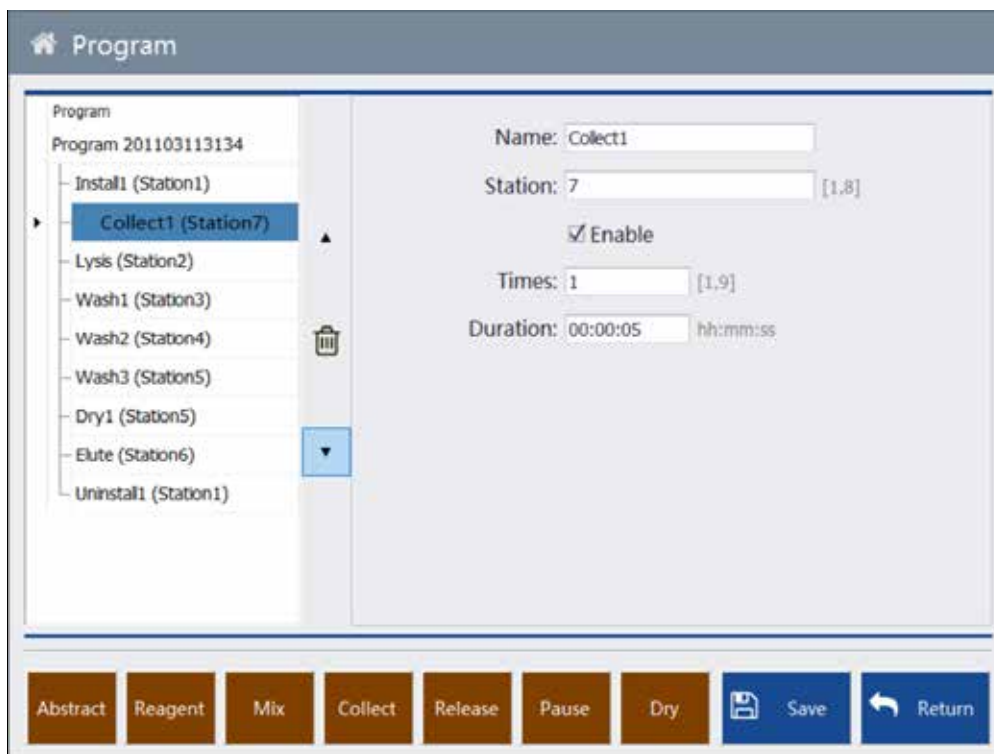

Figure 4-9 Collect

Name: default set is collect magnetic beads 1, and 1 represents the first collection step. If you click "collect" again, it will display "collect magnetic beads 2", "collect magnetic beads 3"..., the operator can modify accordingly;

Work station: select the work station of the collection step;

Enable: select whether to enable the collecting magnetic beads step, it is enabled by default. If not selected, the step will be skipped and execute the next step directly;

Times: the number of collections;

Time: set the residence time;

Release: This function is mainly to release the magnetic beads on the magnetic rod sleeve into the kit, including the released position, time, speed settings, etc. As shown in Figure 4-10.

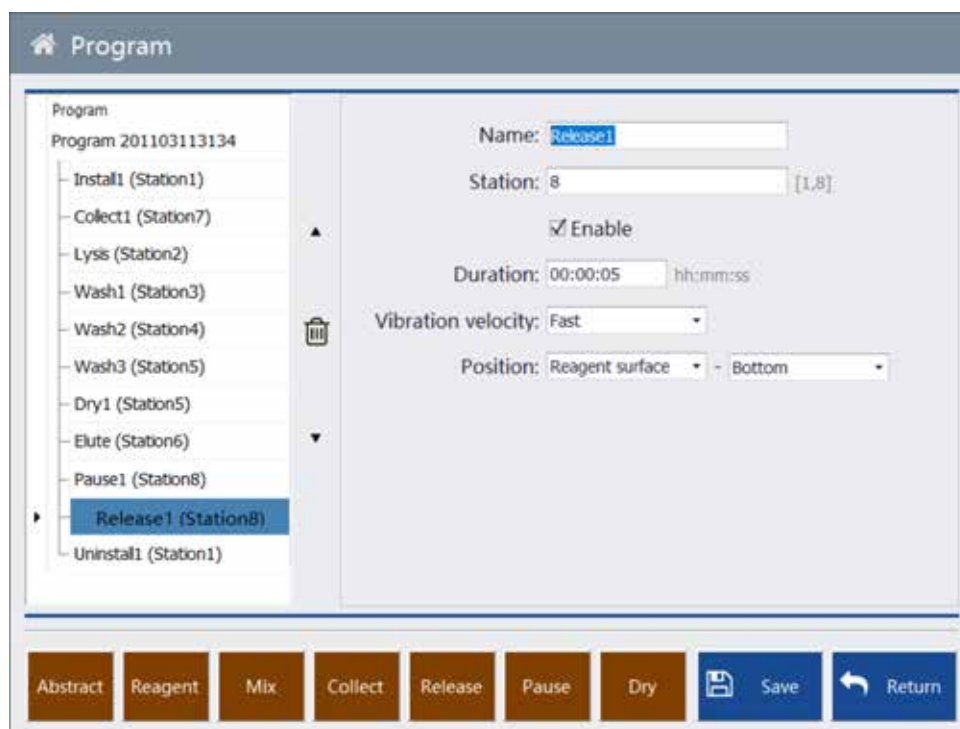

Figure 4-10 Release

Name: The default is to release magnetic bead 1. 1 represents the first release step. If you click "Release" again, it will display "Release Magnetic Bead 2", "Release Magnetic Bead 3"... and the operator can modify accordingly;

Work station: select the work station of the release step;

Enable: select whether to enable the collecting magnetic beads step, it is enabled by default. If not selected, the step will be skipped and execute the next step directly;

Time: set the running time;

Vibration speed: Set the speed of the up and down movement of the magnetic rod sleeve, and three speeds to set: fast, medium and low;

Position: Set the operating position of the vibration action inside the reagent. The first parameter is the starting position of the vertical direction, and the second parameter is the end position of the vertical direction. There are seven positions that can be set: the surface, 3/4, 2/3, 1/2, 1/3, 1/4 and the bottom;

If multiple release is required in the program, please set multiple releases and set the corresponding work stations.

Pause: This function is used to pause the following steps of the program, and in the meantime to run the set work station to the hatch door and give prompt, generally used to add reagents or samples during the extraction process, as shown in Figure 4-11.

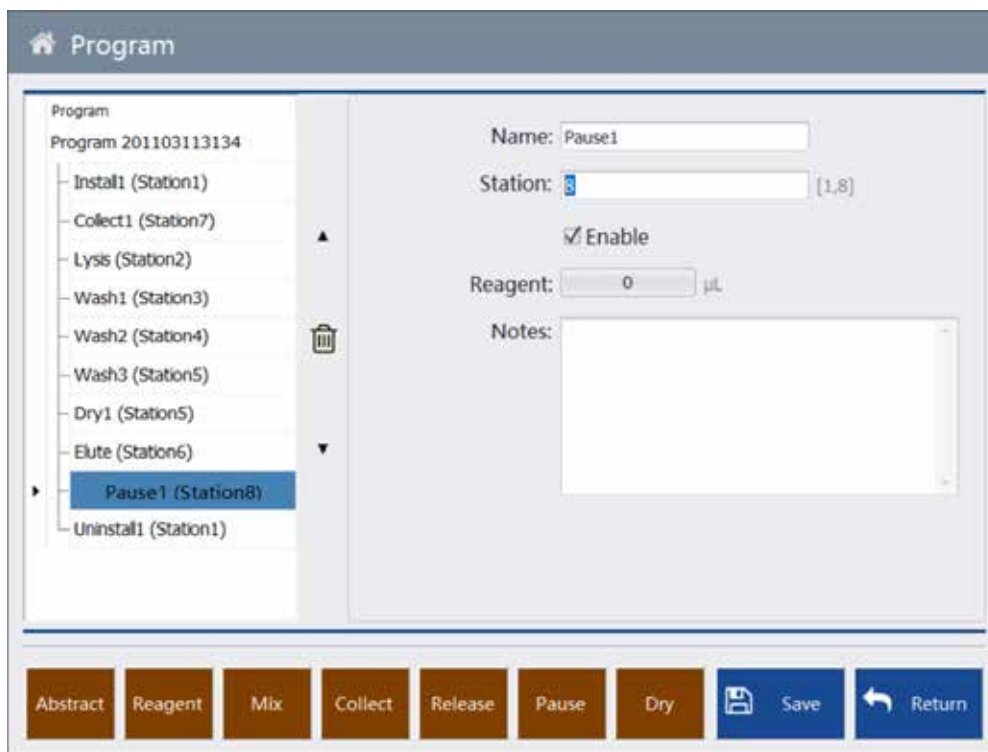

Figure 4-11 Pause

Name: The default set is Pause 1, which is the same as the name of the mixing step, and the user can modify it according to their needs;

Work station: select the work station for the pause step;

Enable: select whether this pause step is enabled. It is enabled by default. If not selected, this step will be skipped, and the next step will be executed directly;

Reagent: set the reagent and reagent volume added during pause;

Message Prompt: Set the message prompt given to the user when pause;

Drying: This function lifts the magnetic rod sleeve out of the liquid to dry, as shown in Figure 4-12.

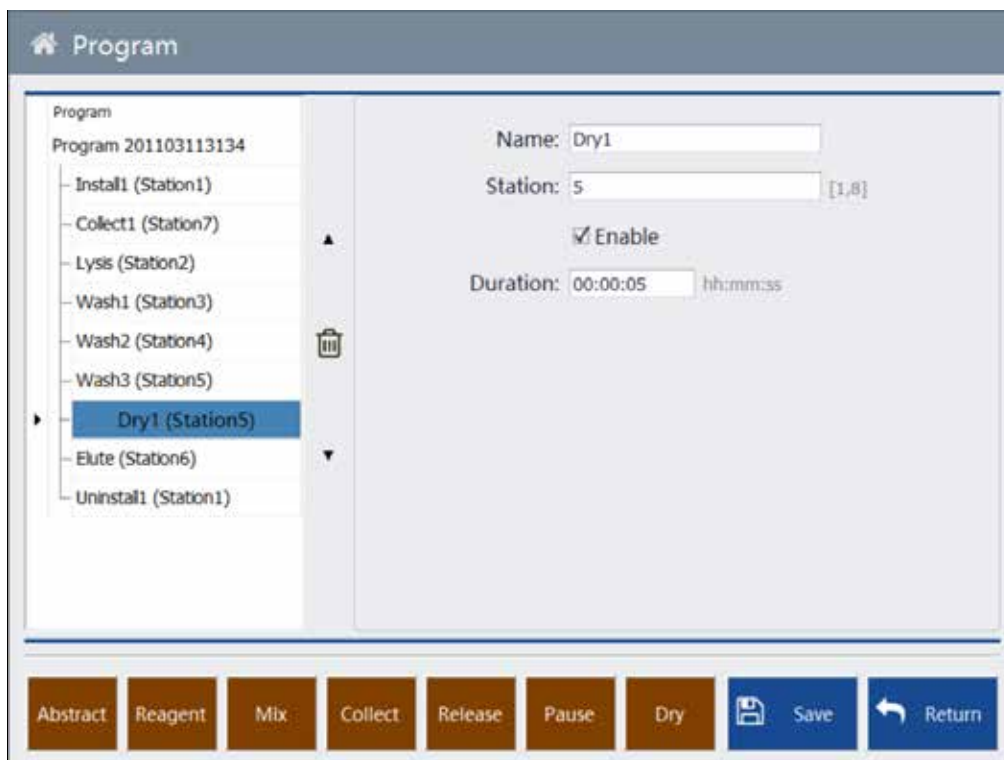

Figure 4-12 Drying

Name: The default is Dry 1, which is the same as the name of the mixing step, and the user can modify it according to their needs;

Work station: select the work station for the drying step;

Enable: select whether this drying step is enabled. It is enabled by default. If not selected, this step will be skipped, and the next step will be executed directly;

Time: Set time for drying the magnetic beads;

The program compiled by the user will be displayed in the form of a list on the left side of the page, and the user can directly see the execution flow of the program that was compiled. The number in parentheses after each step represents the work station where the step is executed.

The user can select a step in the step list on the left, adjust the position of the step through the "▲"

and "▼" buttons on the interface, and  button to delete the step.

In the process of programming, you can click the "Save" button to save at any time. After the programming is complete, click the "Return" button to return to the program list.

4.2.2 Edit

This function is used to modify the compiled program. In the program list, select the compiled programs and click the "Edit" button to edit the selected program. Interface and operating method of the editing interface is consistent with the "Add" interface.

4.2.3 Delete

This function is used to delete the compiled program in the program list. In the program list, select the program to be deleted, click the "Delete" button, a message box will pop up, and click the "Yes" button to delete the program.

4.2.4 Copy

This function is used to copy a program that is the same as in the program list. Select a program in the list and click the "Copy" button, a program that is the same as the selected one appears in the list. The program name is automatically added with (1). If you continue to copy, the number in the parentheses continues to extend.

4.2.5 Import

This function is used to import the program that compiled and stored in the U disk into the program list, as shown in Figure 4-13.

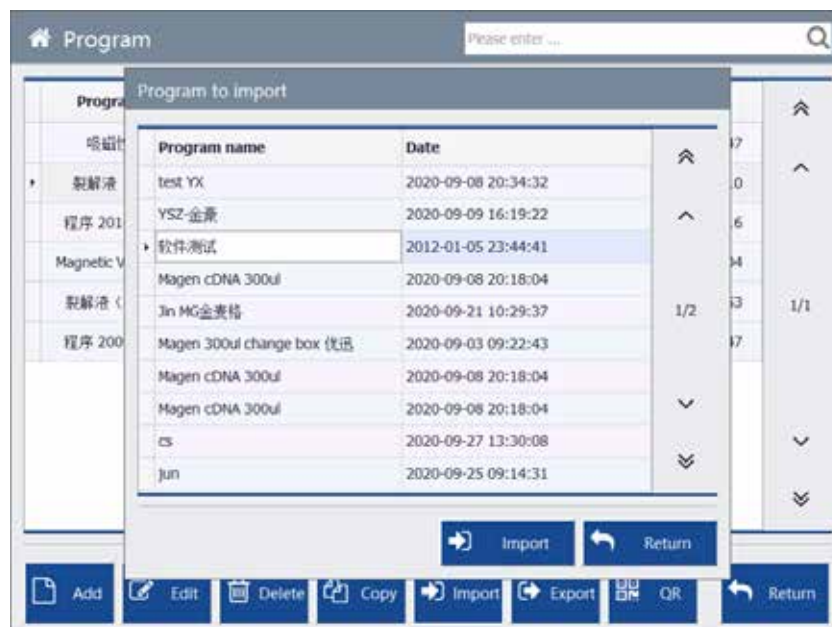

Figure 4-13 Import

Click "Import" and a dialog box will pop up, displaying the list of programs in the U disk. Select the program to be input, and click the "Import" button in the dialog box to import the program into the program list.

Note: Please insert the U disk before performing this step and the following "Export" function.

4.2.6 Export

This function is used to export a certain program selected from the program list to a U disk for storage. Select the program that needs to be export, click "Export", the successful export prompt is shown in Figure 4-14.

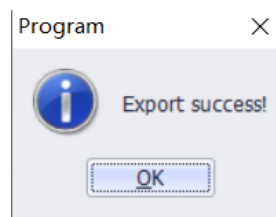

Figure 4-14 Export

4.2.7 Return

Click the "Return" button to return to the main interface.

4.3 Pre-set Program Extraction

Select "Extraction" in the main interface to enter the program extraction interface, as shown in Figure 4-15. All newly added or edited programs in the program management will be displayed in this list.

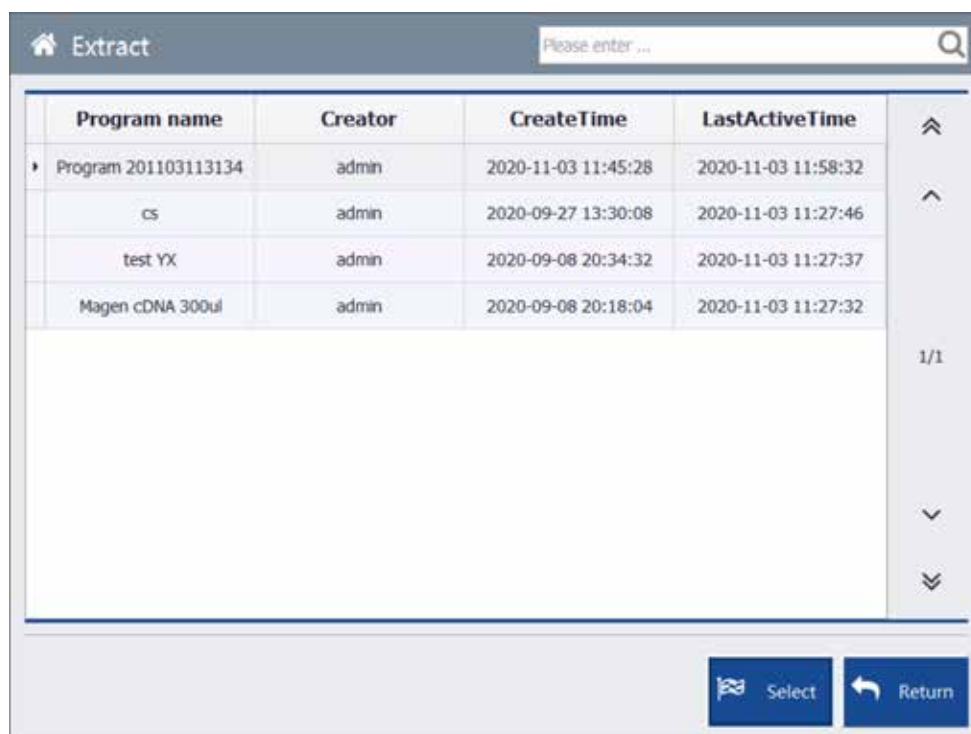

Figure 4-15 Nucleic Acid Extraction

Select the program to be run on this interface. At this time, the program is displayed in blue. Click "Select" to enter the program display interface, as shown in Figure 4-16. On the left side of this interface, the current work station is displayed at the hatch door. On the right side displays the information and execution steps of the selected program. Now click the turntable button to place consumables and corresponding reagents.

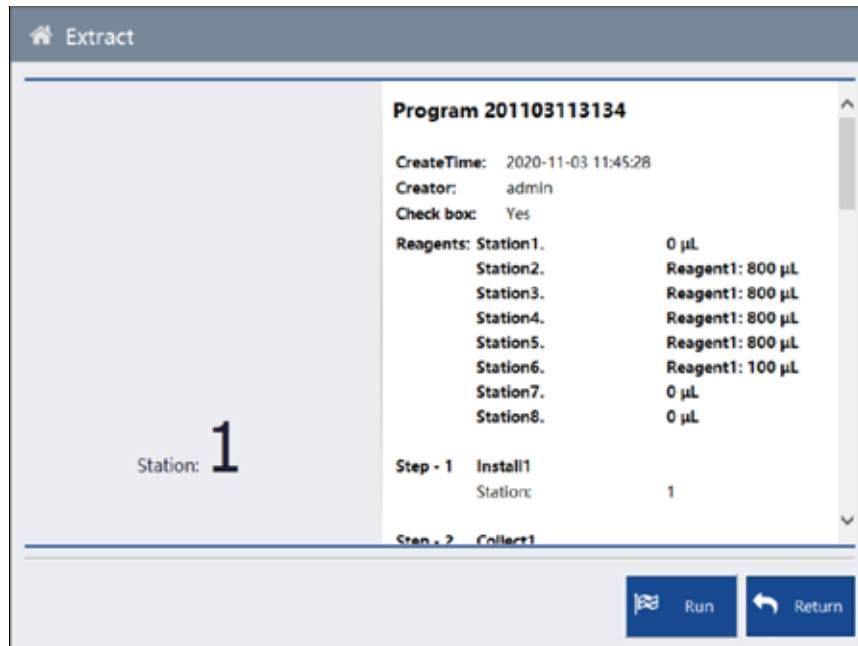

Figure 4-16 Program Information

Click "Execute" on this interface, the device will judge whether the well plate has been inserted according to the program information, and click the "Return" button to return to the preset program interface.

When the device detects no installed well plate, it will give a prompt, as shown in Figure 4-17.



Figure 4-17 Place the well plate

When the device detects hatch door is not closed, it will give a prompt, as shown in Figure 4-18.



Figure 4-18 Close the hatch door

Follow the prompts and click "Execute" to enter the extraction process display interface, as shown in Figure 4-19. The device starts nucleic acid extraction.

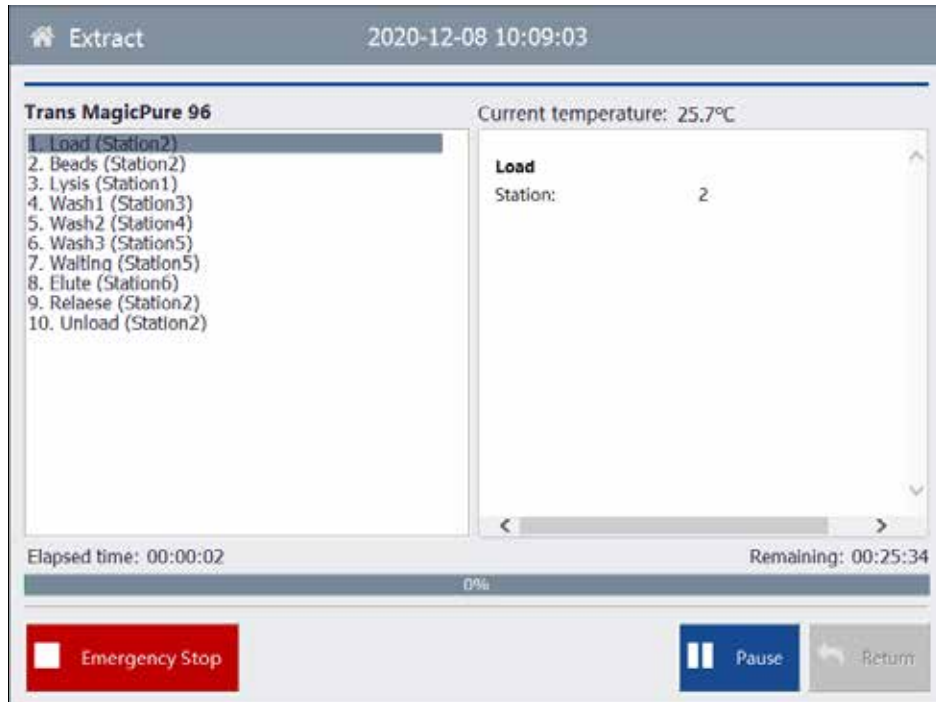

Figure 4-19 Extraction process display

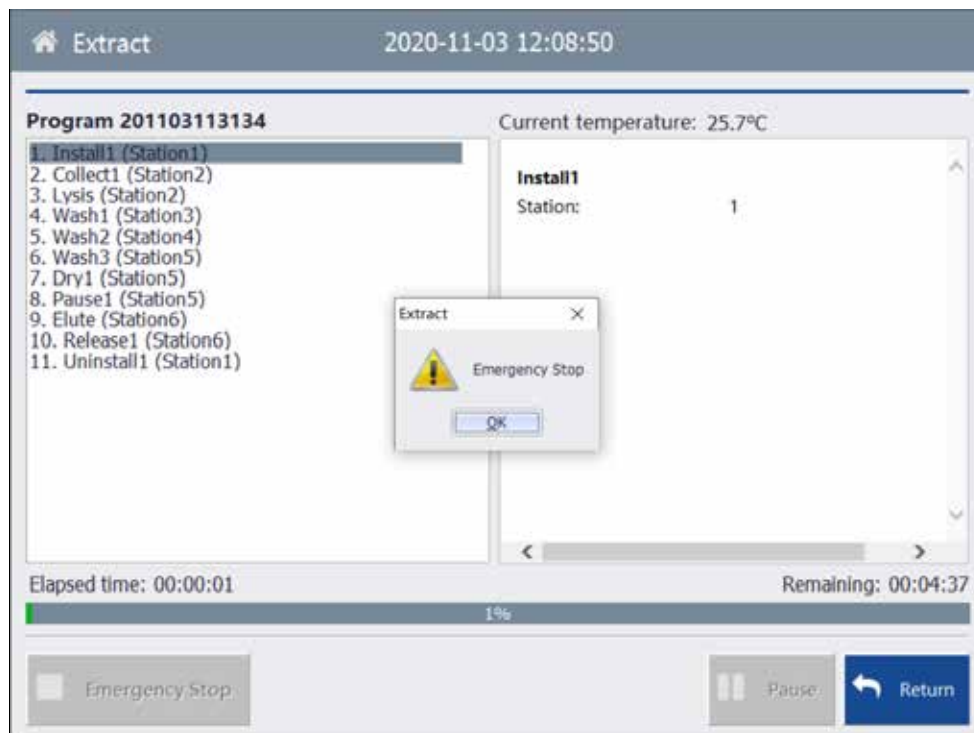

Figure 4-20 Emergency Stop

In case of an emergency, the user can click the button of "Emergency Stop" to control the device. At this time, the operation will stop, and the "Emergency Stop" prompt will pop up with a beep

sound, as shown in Figure 4-20, press "OK" button to close the prompt, and then click the "Return" button to return.

During the execution of a program, the user can also click the "Pause" button to pause the program. At this time, the "Pause" button changes to the "Continue" button and beep sounds. After click the "Continue" button, the extraction program continues to operate.

In the process of program execution, if the user opens the hatch door, the program is paused with beep sounds. When the door is closed, the device continues the previous operation after click the "Continue" button.

If there is a "pause" step in the extraction procedure, when executing this step, the device will pop up a prompt window with a beep sound according to the remarks of the pause step. If you need to add reagents at this time, please open the hatch door and take out the kit to add reagent. Then put the required reagents back to the test chamber, close the hatch door, click the "OK" button in the prompt message box on the screen, and then click the "Continue" button, and the device will continue to execute the current program.

When the nucleic acid extraction process is completed, the device will pop up a prompt window with a beep sound, as shown in Figure 4-21. At this time, the user can open the hatch door, click the turntable button to rotate the turntable to take out the kit. Click the "Close" button to close the prompt window, and click the "Back" button to return to the main interface.

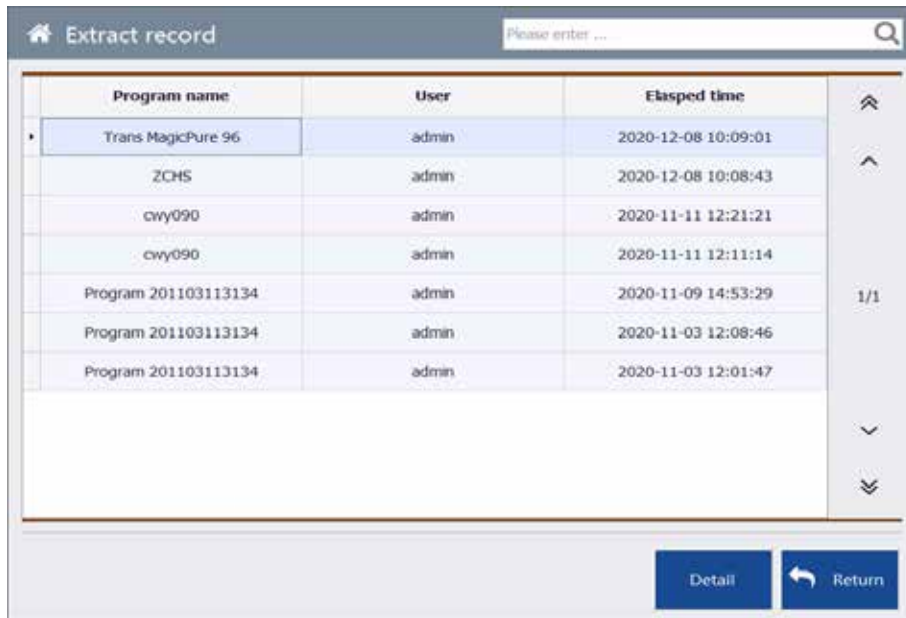

Figure 4-21 The extraction is completed. Please take out the kit.

On the display interface of the extraction process, the user can observe the currently executed nucleic acid extraction program, the currently executed steps and the elapsed time.

4.4 Extraction Records

This function mainly checks the records of the programs operated, including "program name", "user", and "running time", as shown in Figure 4-22.



Program name	User	Elapsed time
Trans MagicPure 96	admin	2020-12-08 10:09:01
ZCHS	admin	2020-12-08 10:08:43
cwy090	admin	2020-11-11 12:21:21
cwy090	admin	2020-11-11 12:11:14
Program 201103113134	admin	2020-11-09 14:53:29
Program 201103113134	admin	2020-11-03 12:08:46
Program 201103113134	admin	2020-11-03 12:01:47

Figure 4-22 Extracting records

Select an extraction record and click the "Detailed Information" button to view the specific information of the running program, as shown in Figure 4-23.

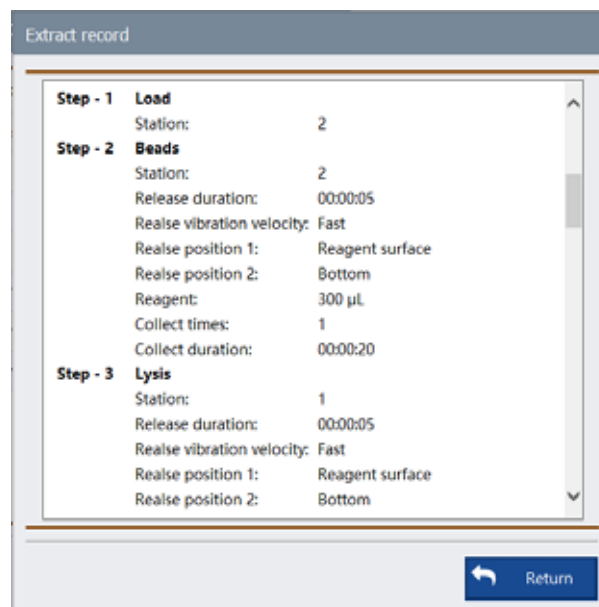

Step	Operation	Parameter	Value
Step - 1	Load	Station:	2
		Release duration:	00:00:05
Step - 2	Beads	Release duration:	00:00:05
		Release vibration velocity:	Fast
		Release position 1:	Reagent surface
		Release position 2:	Bottom
		Reagent:	300 µL
		Collect times:	1
Step - 3	Lysis	Collect duration:	00:00:20
		Station:	1
		Release duration:	00:00:05
		Release vibration velocity:	Fast
		Release position 1:	Reagent surface

Figure 4-23 Detailed Information

Users can also enter keywords in the upper right corner to search.

4.5 UV lamp

Select "UV lamp" on the main interface to enter the UV lamp interface, as shown in Figure 4-24. It displays the "Set UV lamp time", "Shutdown after disinfection" and "OK" and "Return" buttons. User can set the time for the UV lamp in the hour, minute or seconds by clicking + and - buttons. Select "Shutdown after disinfection", the device will shut down after disinfection.



Figure 4-24 UV lamp

After setting the UV lamp time, click the "OK" button to turn on the UV lamp, in the meantime the device will return to the main interface, and the remaining time will be displayed on the interface, as shown in Figure 4-25. If you need to turn off the UV lamp at this time, click this button on the main interface to turn off the UV lamp.

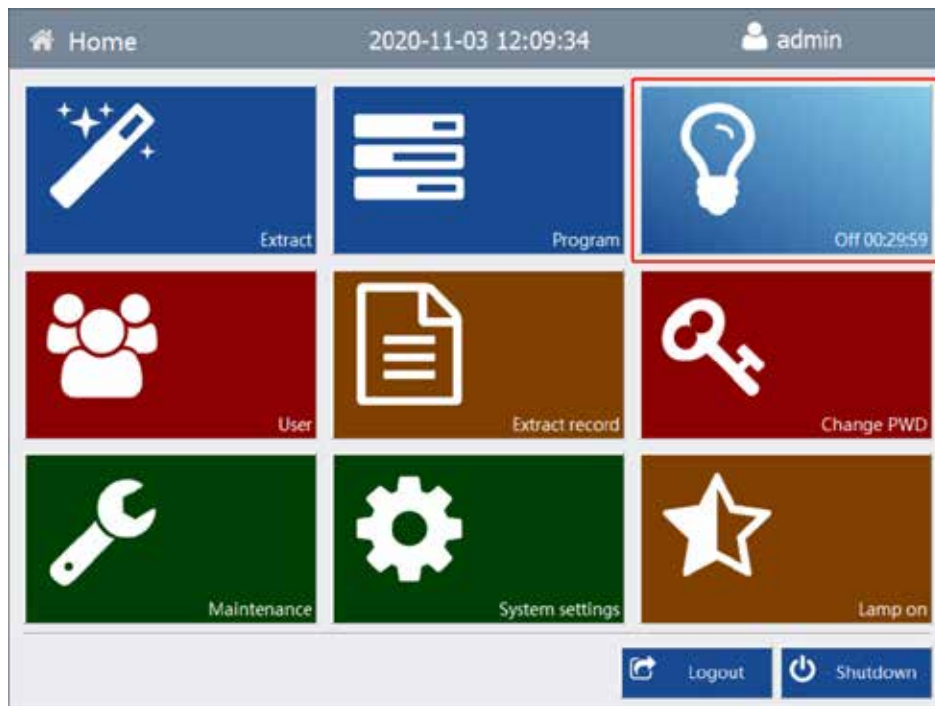

Figure 4-25 UV lamp countdown display

On the UV lamp setting interface, if click the "Cancel" button, it will directly return to the main interface without turning on the UV lamp.

If the UV lamp is on and the hatch door is opened at this time, the UV lamp will automatically turn off and the countdown will pause. When the door is closed, the UV lamp will continue to turn on till the countdown ends.

4.6 User Management

Click "User Management" on the main interface to enter the user management interface. The interface displays "Add", "Edit", "Permissions", "Delete", "Reset Password", and "Return" buttons, as well as admin user information displayed, as shown in Figure 4-26.

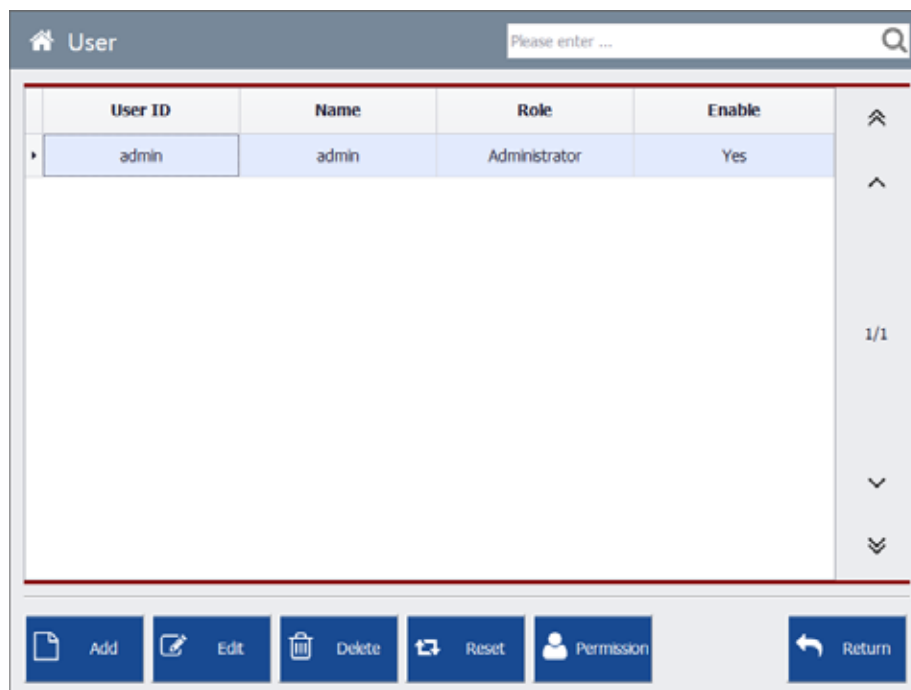

Figure 4-26 User Management

Add: Click the "Add" button to display the new user information, as shown in Figure 4-27, with "User ID", "Name", "Role", "Enable", "Notes" options and "Save" and "Return" buttons displayed.

User ID: fill in the user's ID;

Name: fill in the user's name;

Role: Select the role of the user, such as "Administrator", "Operator" and "Maintenance Engineer" to be selected;

Administrator: execute all function operations;

Operator: The administrator can configure the operator's in the "Permissions";

Maintenance Engineer: The administrator can configure the maintenance engineer's authority in "Permissions";

Permission: select whether this user is enabled, it is not enabled by default. Tick to enable it, otherwise the user is not authorized to log in;

Notes: fill in other user information;

After editing the user information, click the "Save" button to save the new information, and click "Return" to return directly to the user management interface.

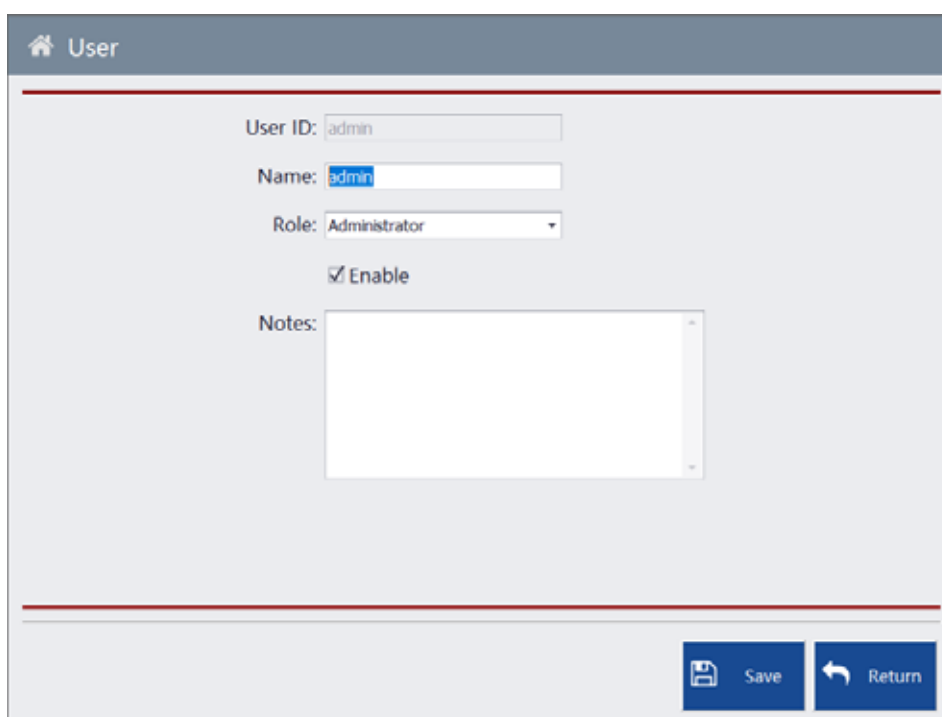

The screenshot shows a web interface titled "User" for adding a new user. The form contains the following elements:

- User ID:** A text input field containing "admin".
- Name:** A text input field containing "admin".
- Role:** A dropdown menu currently set to "Administrator".
- Enable:** A checkbox that is checked.
- Notes:** A large, empty text area for additional information.
- Buttons:** At the bottom right, there are two buttons: "Save" (with a floppy disk icon) and "Return" (with a back arrow icon).

Figure 4-27 User Management-Add

Edit: Select one of the users to edit or modify. Operation process is the same as "Add". This function cannot modify the user's account.

Permission: Click the "Permission" button to configure the functional modules that each user can enter, as shown in Figure 4-28

User ID: The user's account, which cannot be modified;

Name: The name of the user, which cannot be modified;

Eight options such as "Nucleic Acid Extraction", "Program Management", "Ultraviolet Lamp", "Extraction Record", "Modify Password", "Maintenance Test", "System Setting" and "Lighting

Lamp" can configure each user' permission to the corresponding function modules. Check means the current user can use this function.

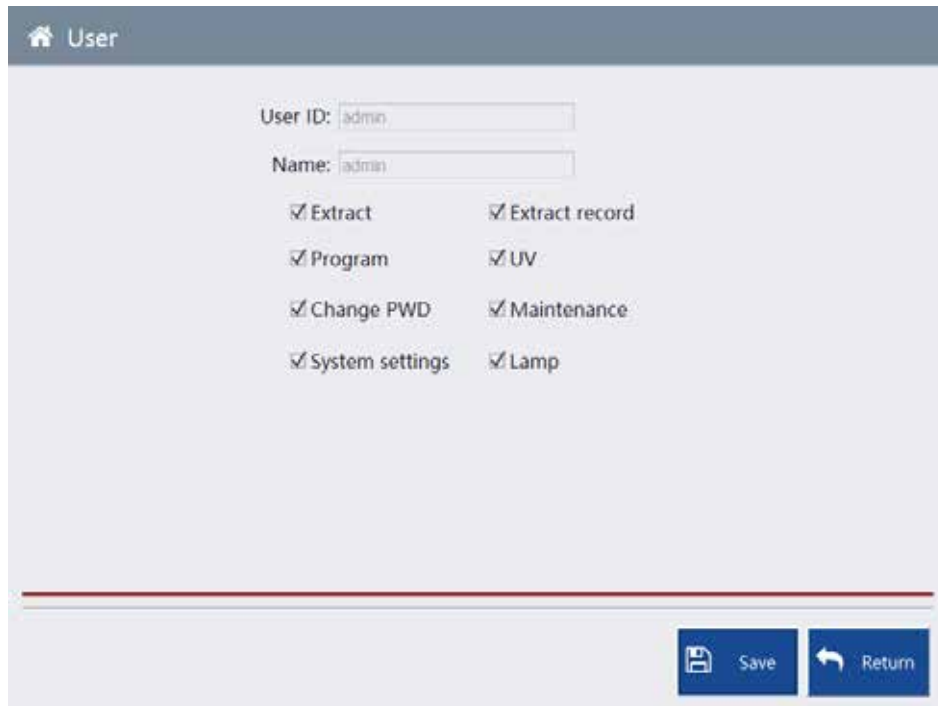

Figure 4-28 User Management-Permissions

Delete: When select a user, click "Delete" and a message box will pop up. Click "Yes" to delete the user. This function can be used by the administrator only.

Reset Password: This function is used to reset the password of the selected user. If the step is executed, the password is forced to reset to 000000.

Return: Return to the main interface.

4.7 Change Password

Click the "Change Password " button on the main interface, and the change password interface appears, as shown in Figure 4-29.

Account: Display the currently logged-in account, only the current log-in account is allowed to be modified;

Name: Insert the name of the operator corresponding to the account;

Original password: Insert the original password of the current user;

New password: Insert the modified password;

Confirm new password: Confirm the modified password;

When the above operation is completed, press the "Save" button to complete the modification of the password, and press the "Return" button to return to the main interface without modifying the password.

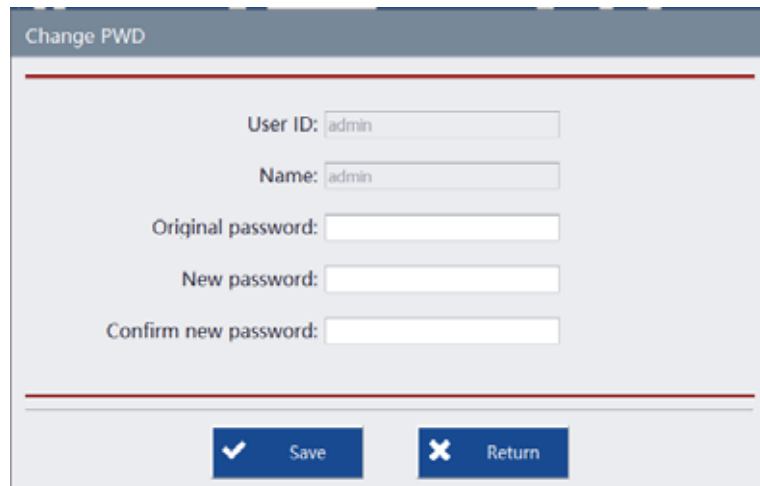

The image shows a 'Change PWD' (Change Password) interface. It features a title bar at the top with the text 'Change PWD'. Below the title bar, there are five input fields: 'User ID:' with the value 'admin', 'Name:' with the value 'admin', 'Original password:', 'New password:', and 'Confirm new password:'. At the bottom of the interface, there are two buttons: a blue button with a checkmark icon and the text 'Save', and a blue button with an 'X' icon and the text 'Return'.

Figure 4-29 Change Password

4.8 Maintenance Test

Click the "Maintenance" button on the main interface to enter the maintenance test interface. It consists of five modules: "Magnetic Rod Sleeve Module", "Turntable Module", "Magnetic Rod Module", "Heating Module" and "Other Modules", as shown in Figure 4-30.

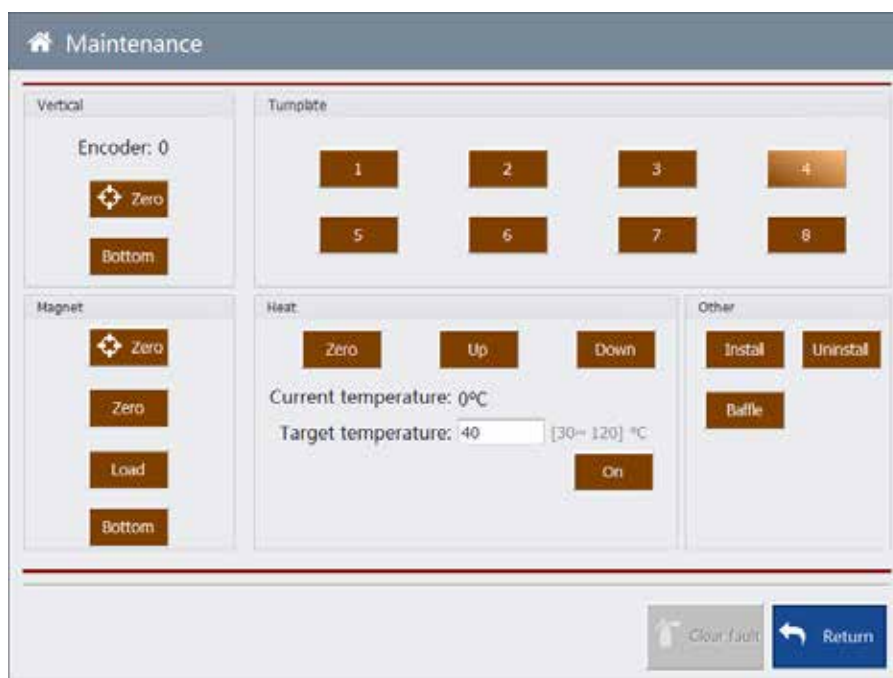

The image shows a 'Maintenance' interface with a title bar containing a home icon and the text 'Maintenance'. The interface is divided into five main sections: 'Vertical', 'Turnplate', 'Magnet', 'Heat', and 'Other'.
 - 'Vertical' section: 'Encoder: 0', 'Zero' button, 'Bottom' button.
 - 'Turnplate' section: Eight numbered buttons (1-8) arranged in a 2x4 grid.
 - 'Magnet' section: 'Zero' button, 'Zero' button, 'Load' button, 'Bottom' button.
 - 'Heat' section: 'Zero' button, 'Up' button, 'Down' button, 'Current temperature: 0°C', 'Target temperature: 40 [30-120] °C' (with a text input field), 'On' button.
 - 'Other' section: 'Instal' button, 'Uninstal' button, 'Baffle' button.
 At the bottom right of the interface, there are two buttons: a grey button with a trash can icon and the text 'Clear fault', and a blue button with a left-pointing arrow and the text 'Return'.

Figure 4-30 Maintenance Test

Magnetic Rod Sleeve Module:



"Set Zero ": Zero position of vertical motor;

Bottom Position: The magnetic rod sleeve motor set to the lowest position;

Turntable Module: 8 work station serial numbers of the turntable are used to test the turntable motor and position. Randomly click any button of the work station from 1 to 8, and the turntable will rotate the work station to the hatch door;

Magnetic Rod Module: The magnetic rod motor moves to the corresponding position through four instructions: "Set Zero", "Zero Position", "Hook & unhook position" and "Bottom position".



"Set Zero ": the magnetic rod motor sets to the zero position;

Zero Position: the magnetic rod motor moves to the set zero position;

Hook & Unhooking position: the magnetic rod motor moves to the hook & unhook position;

Bottom position: the magnetic rod motor moves to the bottom position;

Heating Module: the heating motor moves to the corresponding position through "Set Zero", "Heating Top", "Heating Bottom". The target temperature input box can be filled in the temperature that needs to be heated, and control the heating start/stop by the start/stop heating instructions. "Current temperature" displays the current temperature.

Set zero: the heating module moves to the zero position;

Heating top: the heating module moves to the top position;

Heating bottom: the heating module moves to the bottom position;

Other Modules: install and demagnetize the magnetic rod sleeve, rotation of the baffle, corresponding motor test.

Install the magnetic rod sleeve: the turntable 1 work station moves under the magnetic rod, to perform the magnetic rod sleeve installation action;

Demagnetize rod sleeve: the turntable 1 work station moves under the magnetic rod to perform the demagnetizing rod sleeve action;

Baffle test: The baffle returns to a fixed position after moving under the magnetic rod;

When the device has a malfunction, the "Clear Errors" button will be on. Click this button to clear the fault; Click the "Return" button to return to the main interface.

4.9 System Settings

Click "System Settings" on the main interface to enter the system settings interface.

 Warning: The parameters in the system are set by the manufacturer, and operators is not allowed to modify.

V Repair and Maintenance

5.1 Maintenance Guidelines

- ❗ The device shall be placed in a ventilated and dry place;
- ❗ Handle the device with care;
- ❗ The device shall avoid contact with corrosive gas or liquid;
- ❗ The device can be cleaned with a clean soft cloth dipped in a small amount of 75% alcoholic solution;
- ❗ The LCD screen shall be kept clean for clear display;
- ❗ Keep away from heavy objects hitting or scratching by sharp objects;
- ❗ Turn off the power if the machine is not running.

5.2 Periodic Check

The device must be inspected regularly to maintain safety, function, performance and reliability. Please perform periodic check according to the "Periodic Checklist". If any item in the periodic check fails to meet the standard, you should not continue to use the device. During periodic check, visual and functional check shall be adopted in sequence. Corrective measures shall be taken if items fail to meet the requirement. TS-96 Automated Nucleic Acid Extractor can only be used after all items meet the requirements. The following checks must be performed at least once a year.

Table 5-1 Periodic Checklist

Type	Check Items	Check Procedure	Requirement
Appearance Check	LCD display touch control function	Observe the display interface and perform touch operations, after the device is started.	Normal display, no black/white/ blurred screen phenomenon, touch sensitively.

Functional Check	Turntable movement function	Enter the maintenance test function module of "Maintenance Test" on the main interface, and click at random between 1~8 under the column of the turntable module.	The corresponding turntable work station moves to the hatch door
	Magnetic rod up and down movement function	Enter the "Maintenance Test" function module on the main interface, and click the "Set Zero" and "Bottom Position" buttons in the magnetic rod check tab.	The magnetic rod moves up or down respectively
	Magnetic rod sleeve up and down movement function	Enter the "Maintenance Test" module on the main interface, and click the "Set Zero" and "Bottom Position" buttons in the magnetic rod sleeve check tab.	The magnetic rod sleeve moves up or down respectively
	Baffle movement function	Enter the Maintenance Test function module in the main interface, and click baffle test button under the "Other Modules".	The baffle performs a shielding function, and returns to a fixed position after running under the stirring head.
	UV disinfection function	Enter the "UV Lamp " module on the main interface, set operation time for 5 sec , and click the "OK" button	The UV lamp is turned on. It is turned off after the set time.

Note: Please install the magnet rod sleeve at work station 1 of the turntable before checking the installation and uninstallation function of the magnet rod sleeve.

 Note: In case of any malfunction of the device, shut down the device and cut off the power supply immediately, and contact the manufacturer for maintenance.

 Note: The protection system provided by the device may be damaged if the device is not used as instructed.

 Warning: The device shall not be used if it operates abnormally. It can be reused after repair and maintenance is conducted by the manufacturer's technicians. Replacement parts shall only be provided or checked by the manufacturer.

 Warning: If the device is ceased of use, or during transportation or under treatment, make sure that the experimental consumables are removed from the device, and close the hatch door if necessary.

5.3 Common Fault Analysis

This section provides reference suggestions and basic solutions for the problems that the TS-96 Automated Nucleic Acid Extractor may occur. If these methods cannot solve your problem, please contact our company in time.

1. Fail to start up.

- Check the power grid system, including power sockets, power cords and power outlets and see if it is disconnected;
- Check whether the power button switch on the right side of the device is turned on and whether the indicator light is on;
- Disconnect the power supply and check the fuse of the extractor. In case of fuse failure, replace the fuse after checking and troubleshooting.

2. Fail to pass the self-test.

- Restart the device and check whether it can pass the self-test.

3. The UV lamp does not turn on.

- Disconnect the power supply and check if UV lamp has a positional shift;
- Remove the UV lamp and check if the filament is fused;
- Reinstall the UV lamp, turn it on, and check if it lights up.

4. The magnetic rod sleeve cannot be properly installed and removed

- Check whether the kit and magnetic rod sleeve are installed correctly and evenly;

- Conduct the function of installing the magnet rod sleeve in the check function module to check whether the position of the magnet rod and the magnet rod sleeve are aligned and well installed. If not, please contact the manufacturer for adjustment.

5. The motor moves up and down abnormally during operation.

- Enter maintenance test, click magnetic rod sleeve up and magnetic rod sleeve down respectively to check whether the magnetic rod sleeve motor operates normally;
- Enter the maintenance test, click the magnetic bar up and down respectively to check whether the magnetic rod motor operates normally.

6. The turntable rotates abnormally during operation.

- Enter the maintenance test, click each work stations respectively and check whether the hatch door and the turntable motor operates normally;

7. Abnormal temperature display during operation.

- Enter maintenance test to check whether the temperature is displayed normally;
- Turn on the temperature control and check whether the temperature rises normally.

5.4 Main Components Replacement Method

5.4.1 Fuse Replacement Method

The fuse protector of the nucleic acid extractor is in the fuse box at the back of the device. Unplug the power cord, pull out the fuse box from the notch of the power port, take out the fuse for replacement. Fuse model: F4AL250V, $\Phi 520$ mm. After replacing the fuse, push the fuse box back to its original position.

5.4.2 Connection Cable Replacement Method

This device is only allowed to use the matched connecting cable. If the matched cable is damaged or lost, please contact the manufacturer for replacement.

VI Electromagnetic Compatibility

Notes on electromagnetic compatibility:

- a) This device complies with the radiation and anti-electromagnetic interference requirements specified in GB/T 18268.1 and GB/T 18268.26.
- b) This device is designed and tested according to Class A device in GB 4824. In a home environment, it may cause radio interference, and protective measures are required.
- c) It is recommended to evaluate the electromagnetic environment before using.
- d) It is forbidden to operate this device near strong radiation sources (such as unshielded RF sources), otherwise it may interfere with the normal operation of the device.

Note 1: The manufacturer is responsible for providing electromagnetic compatibility information of the device to the customers or users.

Note 2: The user is responsible for ensuring the electromagnetic compatibility environment of the device to ensure the device works normally.

VII After-sales Service

7.1 Warranty

The warranty period of the device is one year. The manufacturer is responsible for the lifetime maintenance of the device. The warranty period begins on the date of delivery of the device. Do not repair the internal the device or conduct dangerous charged operation unless the engineer is trained or authorized by the manufacturer (Note: The warranty period does not include damage caused by human causes, such as collision, improper operation and unqualified working environment).

7.2 Maintenance Service

This device is guaranteed for one year, and the manufacturer charges appropriate maintenance fees for maintenance activities beyond the warranty period.

Within the warranty period, necessary maintenance fee shall also be charged by the manufacturer if the device is damaged by the following misconducts, such as improper use of man-made damage, the voltage of the power grid exceeds the specified range, irresistible natural disasters, replacement of accessories not permitted by the manufacturer, and improper operation by non-authorized personnel, etc.

7.3 After-sales Service Company Information

After-sales service company: TransGen Biotech Co., Ltd.

Address: Building No.4, Zhongguancun Dongsheng International Science Park, No. 1 North Yongtaizhuang Road, Haidian District, Beijing, China

Postal Code: 100192

Contact: +86-400 898 0321